

VG5020KC-MPYIR

f=50mm F2.0 Day & Night
for 1.1 type 12Megapixel Cameras, Fixed-focal, Stepping Motor Iris
C-Mount

Model No.	VG5020KC-MPYIR		Effective	Front	φ 24.7mm		
Focal Length	50mm		Lens Aperture	Rear	φ 18.4mm		
Max. Aperture Ratio	1:2.0		Back Focal Length		14.2mm		
Max. Image Format	14.2mm x 10.4mm (φ 17.6mm)		Flange Back Length		17.526mm		
Operation Range	Iris	F2.0 - F16C		Mount	C-Mount		
	Focus	3m - Inf.		Filter Size	M40.5 P=0.5		
	Zoom	-		Dimensions	φ 42mm × 57mm × 48.8mm		
Control	Iris	Stepping Motor		Weight	121.9g		
	Focus	Manual					
	Zoom	-					
Angle of View	D	1.1 type	19.4°	1 type	17.7°	2/3 type	12.2°
	H		15.7°		14.2°		9.8°
	V		11.6°		10.7°		7.4°
Operating Temperature	-10°C - +50°C						

Dimensions

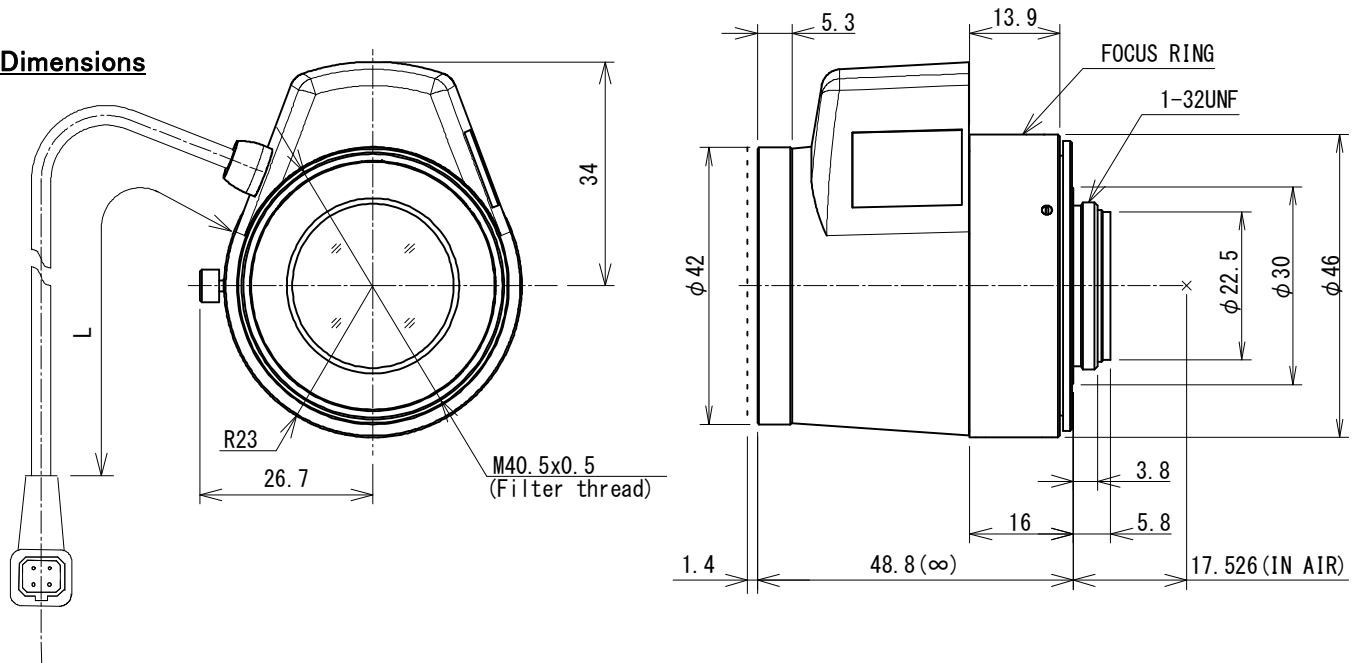

Wiring Diagram

