

MG1218KC-MP

f=12mm F1.8

for 2/3 type 5 Megapixel Cameras, Fixed-focal, Stepping Motor Iris
C-Mount

Model No.	MG1218KC-MP		Effective	Front	φ 20.0mm		
Focal Length	12mm		Lens Aperture	Rear	φ 13.2mm		
Max. Aperture Ratio	1:1.8		Back Focal Length		15.0mm		
Max. Image Format	6.6mm x 8.8mm(φ 11mm)		Flange Back Length		17.526mm		
Operation Range	Iris	F1.8 - F16C		Mount	C-Mount		
	Focus	1m - Inf.		Filter Size	M40.5 × 0.5		
	Zoom	-		Dimensions	φ 42mm × 57.8mm × 45mm		
Control	Iris	Stepping Motor		Weight	103 g		
	Focus	Manual					
	Zoom	-					
Angle of View	D	2/3 type	48.0°	1/2 type	36.0°	1/3 type	27.4°
	H		39.3°		29.1°		22.0°
	V		30.0°		22.0°		16.6°
Operating Temperature	-10°C - +50°C						

Dimensions

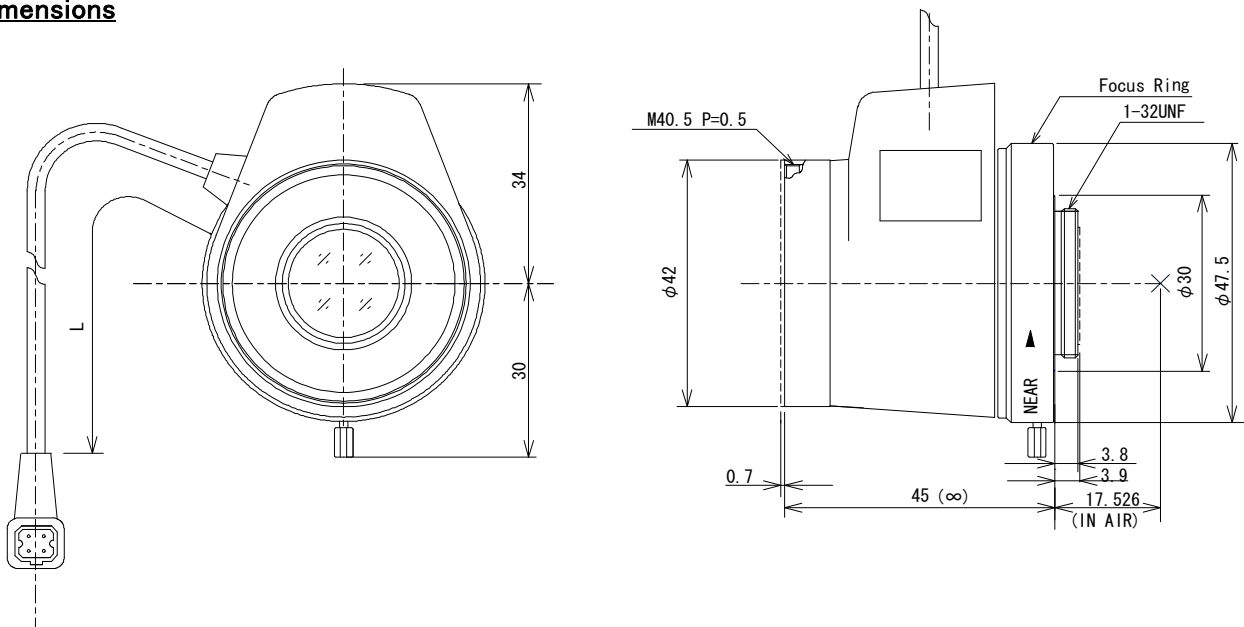

Wiring Diagram

